



**X5PR0F01 PROFIBUS™ COMMUNICATION
OPTION BOARD FOR THE X5 AC DRIVE
INSTALLATION MANUAL**

DPD00114A

Need Help?

This manual answers most installation and startup questions that may arise. However, if you have any problems, please let your first call be to us.

Vacon, Inc.
Chambersburg, PA 17202

Normal business hours:
(North America)

8:00 AM to 5:00 PM, Eastern time

+1 877-Vacon06

(+1 877-822-6606)

After-hours support is also available



and Vacon, Inc. are trademarks of Vacon Plc, a member of Vacon Group.
All other product names are trademarks of their respective companies.

Copyright 2009, Vacon, Incorporated. All rights reserved.

INSTALLING THE X5PROFI01 COMMUNICATION OPTION BOARD

INTRODUCTION

The X5 frequency converters can be connected to Profibus DP using an option board, the X5PROFI01. The converter can then be controlled, monitored, and programmed from the host system.

Profibus is a vendor-independent, open fieldbus standard for a wide range of applications in manufacturing, process and building automation. Vendor independence and openness are guaranteed by the Profibus standard EN 50 170. With Profibus, devices made by different manufacturers can communicate without special interface adjustments. Profibus is useful for both high-speed, time-critical data transmission, and for extensive complex communication tasks. The Profibus family consists of three compatible versions:

Profibus DP

Optimized for high-speed and inexpensive connection, the Profibus DP version is designed especially for communication between automation control systems and distributed I/O at the device level. Profibus DP can be used to replace parallel signal transmission with 24 V or 0 to 20 mA. Profibus DP is the version of Profibus used in the X5 drive units.

Profibus PA

Profibus PA is designed especially for process automation. It permits sensors and actuators to be connected on one common bus line even in intrinsically safe areas. Profibus PA permits data communication and power over the bus using a two-wire technology according to international standard IEC 1158-2.

Profibus FMS

Profibus FMS is the general-purpose solution for communication tasks at the cell level. Power FMS services open up a wide range of applications and provide great flexibility. Profibus FMS can also be used for extensive and complex communication tasks.

Profibus specifies the technical and functional characteristics of a serial fieldbus system with which decentralized digital controllers can be networked together from the field level to the cell level. Profibus distinguishes between master and slave devices.

Master devices determine the data communication on the bus. A master can send messages without an external request when it holds the bus access rights (the token). Masters are also called "active stations" in the Profibus protocol.

Slave devices are peripheral devices. Typical slave devices include input/output devices, valves, drives, and measuring transmitters. They do not have bus access rights and they can only acknowledge received messages or send messages to the master when requested to do so. Slaves are also called "passive stations."

Profiles

The Profibus protocol defines how user data is to be transmitted between the stations over the bus. User data is not evaluated by the Profibus transmission protocol. The meaning is specified in the profiles. In addition, the profiles specify how Profibus is to be used in the application area.

NOTE: This network communication interface included with the X5 option is warranted to meet the core specifications for Profibus. Many existing software applications are custom-engineered and may contain “brand-specific” communication that will not be supported by the X5 without modification. No guarantee of compatibility with any specific system is made. The user is responsible for any interface software and hardware needed to make an application function.

APPLICABLE DOCUMENTS

This manual is supplied as a supplement to the X5 AC Drive User’s Manual (DPD 00089, previously Form 1434).

OPTION KIT CONTENTS

The option kit includes the following materials:

Part Number	Description
25100064C	Profibus PC board assembly
32100391	Flexible cable assembly

INSTALLATION PROCEDURES

⚠ WARNING

SENSITIVE EQUIPMENT

This assembly contains static-sensitive components. It should be handled only by a static-safe installer, using a grounded wrist strap.

Failure to observe this precaution may cause premature equipment failure.

⚠ DANGER

HAZARDOUS VOLTAGE

- Disconnect all power before servicing a drive unit or its components. **WAIT 5 MINUTES** until the DC bus capacitors discharge.
- Ensure that any other power sources that may feed control logic have been disconnected.
- **DO NOT** short across DC bus capacitors or touch unshielded components or terminal strip screw connections with voltage present.
- Install all covers before applying power or starting and stopping the drive.
- The user is responsible for conforming to all applicable code requirements with respect to grounding all equipment.
- Many parts in a drive, including printed circuit boards, operate at line voltage. **DO NOT TOUCH.** Use only electrically-insulated tools.

Before servicing any drive.

- Disconnect all power.
- Place a “DO NOT TURN ON” label on the drive disconnect.
- Lock the disconnect in the open position.

Failure to observe these precautions will cause shock or burn, resulting in severe personal injury or death.

Figure 1 shows the layout of the option board and the location of important components on it.

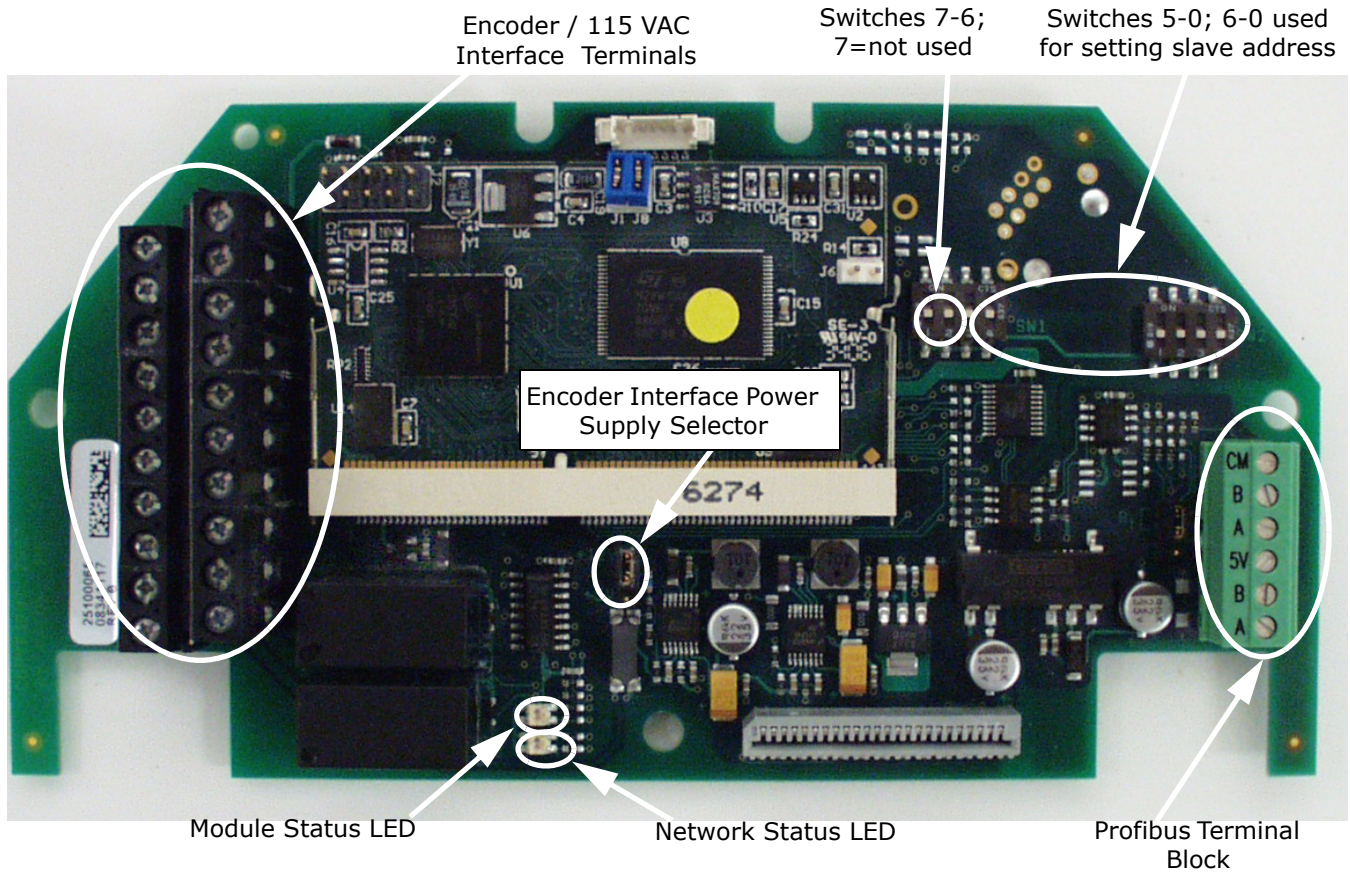

Figure 1: Option board layout

Before you can install the option board, you must first remove the drive cover.

Figure 2 shows the locations of the cover screws. The torque range for the X5 Size 1 cover is 18-26 in/lbs.



Figure 2: Cover assembly and screw locations

The option board is installed just above the control board in all configurations (a Size 1 unit is shown in Figure 3 for reference). The screws labeled “A” must be removed from the X5; those labeled “B” need only to be loosened to accept the board slot.

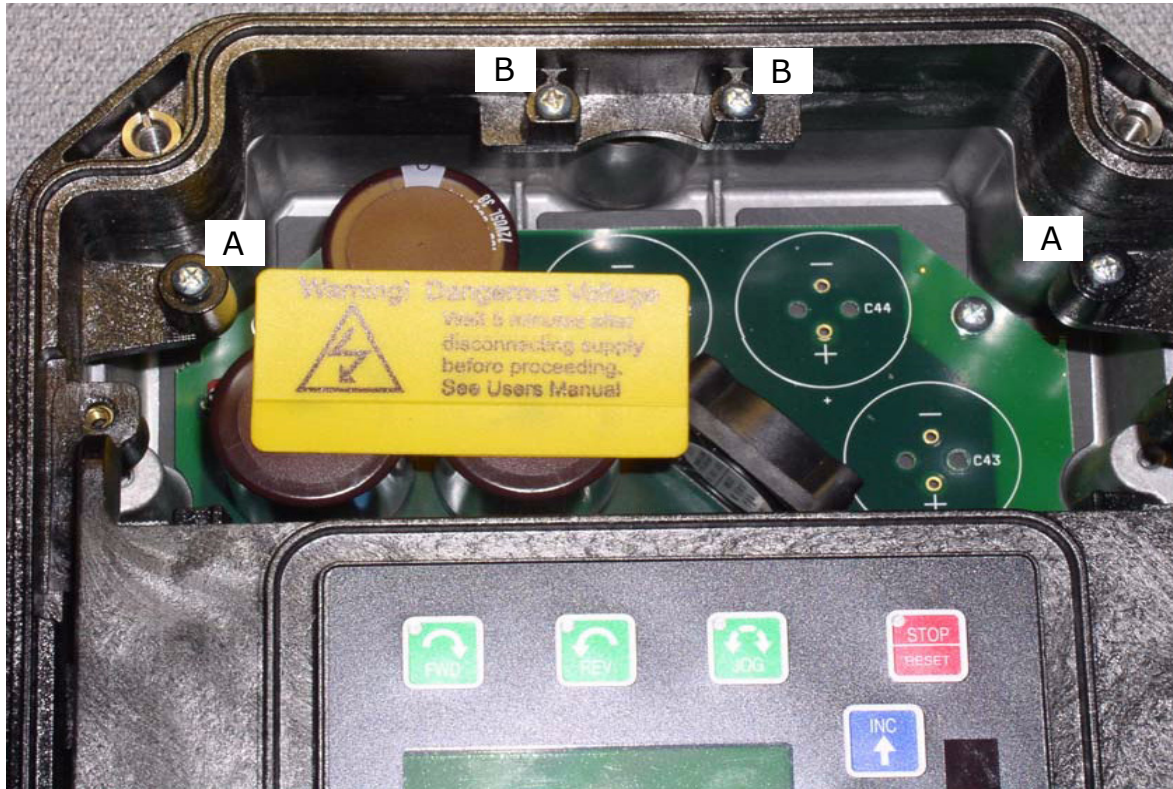

Figure 3: Option board mounting locations

Once the board is in place, tighten the screws to a maximum of 26 in-lbs.

Next, install the flexible circuit to finish the interface to the control board. (Refer to Figure 4.) To install the flexible circuit, first remove the keypad frame (necessary in this size unit). The frame is attached with two screws in opposite corners; the screws thread into fasteners in the plastic assembly. After the flexible circuit is installed, replace these screws, limiting the installation torque to 12 in-lbs..



Figure 4: Flexible circuit interface to control board

115 VAC INTERFACE / RELAY / ENCODER INTERFACE TERMINALS

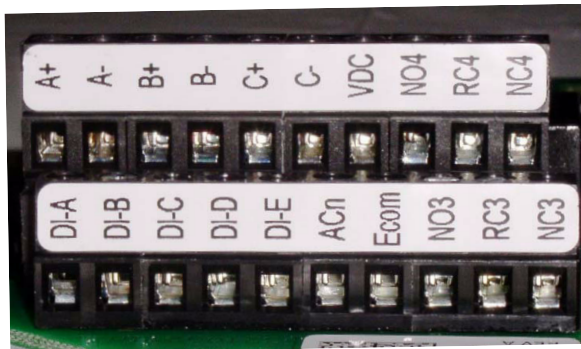

Figure 5: 115 VAC interface / encoder terminals

The option kit includes five 115 VAC inputs, two additional programmable relays, and an encoder interface. The details of the terminals on the board related to the 115 VAC interface and the encoder are shown in [Table 1 on page 8](#):

Table 1: Encoder Interface Terminals

Terminal	Description
DI-A DI-B DI-C DI-D DI-E	115 VAC logic input; connect input to 115 VAC to activate. The programmable functionality of these inputs is controlled by parameters 728, 729, 730, 731, and 732. Each of these inputs can emulate the function of the FWD, REV, R/J, EN, MOL, DI1, DI2, DI3, DI4, or DI5 input terminals on the X5 control board. Refer to the X5 User's Manual for more information (DPD 00089).
ACn	The neutral connection for the 115 VAC control inputs
N03 RC3 NC3	The third auxiliary relay. The function of this relay is set by parameter 709. Functionally, it is capable of each of the features outlined in the X5 user manual under parameters 705-708. Terminal N03 is a normally-open contact; it closes when the relay activates. NC3 is a normally-closed contact; it opens when the relay activates. RC3 is the common terminal associated with both contacts. The ratings of these contacts are 115 VAC, 1 amp; and 230 VAC, 0.5 amp.
N04 RC4 NC4	The fourth auxiliary relay. The function of this relay is set by parameter 710. Functionally, it is capable of each of the features outlined in the X5 user manual under parameters 705-708. Terminal N04 is a normally-open contact; it closes when the relay activates. NC4 is a normally-closed contact; it opens when the relay activates. RC4 is the common terminal associated with both contacts. The ratings of these contacts are 115 VAC, 1 amp; and 230 VAC, 0.5 amp.
A+ A-	Channel A input from the encoder. Compatible with line driver, open collector, or totem pole outputs from an encoder. If it is an open collector or totem pole-type, encoder outputs are used; connect the A- terminal to Ecom.
B+ B-	Channel B input from the encoder. Compatible with line driver, open collector, or totem pole outputs from an encoder. If it is an open collector or totem pole-type, encoder outputs are used; connect the B- terminal to Ecom.
C+ C-	Channel C input from the encoder. Compatible with line driver, open collector, or totem pole outputs from an encoder. If it is an open collector or totem pole-type, encoder outputs are used; connect the C- terminal to Ecom.
VDC	Power supply terminal for use with a customer-supplied encoder. It can be either +12 VDC or +5 VDC based on the position of the encoder interface power supply selector shown in Figure 1 on page 5 . Voltage regulation: +/- 5%; maximum current available is 100 mA.
Ecom	Signal common for the encoder interface

Note that the connections described in [Table 1](#) work only when the encoder has an internal pull-up resistor on the open collector. Alternatively, it might be preferable to pull the + channel high, and attach the open collector to the - channel. For example, if using Channel A, A+ on the option board would be tied to VDC, and A- would be connected to the open collector coming from the encoder. The advantage in this method is that no pull-up/down resistors are needed; if the encoder has an internal pull-up, this does not affect anything.

SPECIFICATIONS FOR THE ENCODER / 115 VAC INTERFACE

Table 2: Encoder / 115 VAC Interface Specifications

Encoder Interface		115 VAC Interface	
Speed regulation	< 0.1 Hz (1)	On state	90-140 VAC
Input frequency (max.)	100 kHz	Off state	< 10 VAC
Input voltage	10-24 VDC +/- 5%	Input frequency	58-62 Hz
Suggested pull-up resistor	5 VDC	500 ohms	On/off delay
	12 VDC	1k ohms	
	24 VDC	3.3k ohms	
Terminal block wire limitations	12-24 AWG	Terminal block wire limitations	12-24 AWG
(1) PID feedback plus optimal motor turning in SLV mode employed			

SETUP AND USE

The encoder interface is most effective if used in conjunction with the vector mode of operation. Refer to the X5 User's Manual (Chapter 6) for information about using the vector mode. Three additional parameters are provided to calibrate the encoder:

Parameter #	Parameter Name	Range	Default Value
219	Encoder Pulses per Revolution	0-16383	1024
220	Encoder Filter Time	10-1000 ms	20 ms
221	Encoder Speed Protection	0-20.0%	0%

Parameter 219, Encoder Pulses per Revolution, can either be extracted from the encoder nameplate or the data sheet supplied with it. Parameter 220, Encoder Filter Time, is used to filter the encoder signal in the event of noise. Parameter 221 is for limiting the response of the drive, in the event of the loss of encoder signal.

Two other parameters are provided to allow more flexibility in encoder selection, and to improve PID application usage:

Parameter #	Parameter Name	Range	Default Value
223	EncoderType	Quadrature or Single Channel	Quadrature
224	Encoder Range	0-24000 rpm	0 rpm

Parameter 223, Encoder Type, allows the use of either quadrature or single-channel types of encoders.

Parameter 224, Encoder Range, improves PID application flexibility. This parameter should be used in situations where the encoder feedback signal is not always directly proportional to the motor speed, for example, a winder using an encoder mounted on an idler pulley feeding a winding spool. The PID may be attempting to maintain a constant linear speed on the wound media, but as the diameter of the media on the spool changes, the motor turning the spool needs to vary its speed to maintain the linear speed at the idler pulley.

When parameter 224 is set to 0, it is ignored, and the PID calculates the feedback percentage based on parameter 301, Maximum Frequency. When this parameter is set to a non-zero value, the PID uses instead Parameter 224's setting to calculate the feedback percentage.

Encoder feedback works similarly to an analog input as configured in parameters 850 (PID Configure), 851 (PID Feedback), 852 (PID Prop Gain), 853 (PID Int Gain), and 859 (PID Derivative Gain). The "feed forward" options are suggested for setting parameter 850. More specific details on each of the listed parameters can be found in the X5 User's Manual (DPD 00089).

The encoder interface can easily serve as one of the inputs to the X5's Keeper Function (data logging). See the X5 User's Manual for more information.

Both the Vmet and lmet output from the drive can be configured to indicate the status of the encoder. Parameters 700 (Vmet) and 702 (lmet) that relate to the setup and calibration of the Vmet and lmet outputs, both have selections related to the status of the encoder input.

The Program Sequencer function can also key off the encoder's home pulse. To make use of this function, the encoder's home pulse (1 pulse per revolution) must be connected to the C- input of the encoder board.

ENCODER INTERFACE TROUBLESHOOTING

Any problem with the encoder interface will result in an F37 fault. Four advanced fault codes are available to help you determine whether you have an encoder calibration problem, or a defect. For more information on troubleshooting, refer to the Troubleshooting chapter in the X5 User's Manual. For information on setting parameters, see Chapter 7 in the X5 User's Manual.

PROFIBUS SPECIFICATIONS AND CONNECTIONS

Following are the specifications for Profibus connections:

Table 3: Profibus Connection Specifications

Profibus Connections	Interface	OPT-C3: pluggable connector (5.08 mm) OPT-C5: 9-pin DSUB connector (female)
	Data transfer method	RS-485, half-duplex
	Transfer cable	Twisted pair (1 pair and shield)
	Isolation	500 VDC
Communications	Profibus	As described in document, "Profibus Profile for variable speed drives, Profidrive"
	PPO types	1, 2, 3, 4, 5
	Baud rate	9.6 kbaud to 12 Mbaud
	Addresses	2 to 126
Environment	Ambient operating temperature	-10 degrees C...55 degrees C
	Storage temperature	-40 degrees C...60 degrees C
	Humidity	<95%, no condensation allowed
	Altitude	Max. 1000 m
	Vibration	0.5 G at 9...200 Hz
Safety		EN50178 standard

Profibus Cable

Profibus devices are connected in a bus structure. A maximum of 32 stations (master or slaves) can be connected in one segment. The bus is terminated by an active bus terminator at the beginning and end of each segment (see

Figure 6). To ensure error-free operation, both bus terminations must always be powered. When more than 32 stations are used, repeaters (line amplifiers) must be used to connect the individual bus segments.

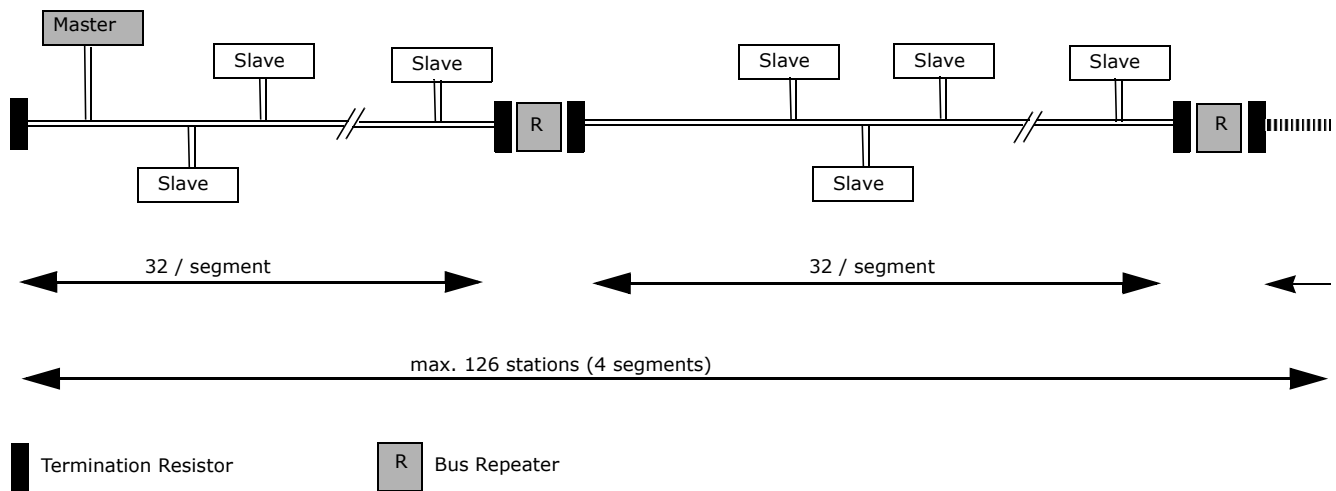

Figure 6: Cabling and bus termination

Table 4 shows the line parameter specifications. The maximum cable length depends on the transmission speed and cable type (see Table 5). The specified cable length can be increased using the repeaters. The use of more than three repeaters in series is not recommended.

Table 4: Line Parameters

Parameter	Line A	Line B
Impedance	135...165 ohms (3 to 20 MHz)	100...130 ohms (f > 100kHz)
Capacity	< 30 pF/m	< 60 pF/ m
Resistance	< 110 ohms/km	-
Wire gauge	> 0.64 mm	> 0.53 mm
Conductor area	> 0.34 mm ²	> 0.22 mm ²

Table 5: Line Length for Different Transmission Speeds

Baud rate (kbit/s)	9.6	19.2	93.75	187.5	500	1500	3000-12000
Length line A (m)	1200	1200	1200	1000	400	200	100
Length line B (m)	1200	1200	1200	600	200	-	-

The following cables can be used:

- Belden Profibus data cable 3079A
- Olflex Profibus cable 21702xx
- Siemens SINEC L2 LAN cable for Profibus 6XVI 830-0AH10

NOTE:

1. The minimum distance between power and bus cables is 30 cm.
2. A minimum cable length of 1 m between two stations is recommended.

The X5PROFI01 Profibus board is connected to the fieldbus through a 6-pin pluggable bus connector. (See Figure 1 on page 5 for the location of the bus connector.) Communication with the control board of the frequency converter takes place through the flexible circuit applied last during the installation process.

PROFIBUS TERMINALS

Table 6 describes the Profibus terminal assignments:

Table 6: Profibus Terminal Block

Signal	Connector	Description
CM	1	Data ground (reference potential for 5V supply)
B	2	Receive / transmit data - plus
A	3	Receive / transmit data - minus
5V	4	5V supply voltage from option board
B	5	Receive / transmit data - plus
A	6	Receive / transmit data - minus

LED INDICATIONS

The Profibus option board includes two status LED status indicators, near the bottom center of the option board. See [Figure 1 on page 5](#) for the location of these LEDs on the board. The following tables explain the meaning of the status LEDs:

Table 7: Top LED

If the LED is...	This means...
OFF	The Profibus option board is not activated.
Green (flashing)	The Profibus option board has started up successfully.

Table 8: Bottom LED

If the LED is...	This means...
OFF	There is no external communication (fieldbus side).
Green	An active connection has been established with a Profibus network.
Red	A Profibus network error has occurred. Check for the following: <ul style="list-style-type: none"> - Bus cable - Possible error in configuration or parameter setting - The master may be offline or shut down.

DIP SWITCHES

The Profibus drop number is configured by the two banks of DIP switches located in the upper right corner of the option board. (See [Figure 1 on page 5](#) for an illustration.) The least significant bit is controlled by the rightmost switch; the most significant bit by the second switch from the left on the left bank. The far leftmost switch on the left bank (switch 7) has no function assigned to it.

The Profibus drop number value is a 7-bit binary number ranging from 0-127. Switches 6-0 set the slave address to a value ranging from 0-127; however, the values 0, 1, and 127 are reserved by the protocol for non-slave devices.

Baud rate is set by the software, not by the DIP switches.

GETTING STARTED USING THE PROFIBUS OPTION BOARD

The X5 Profibus option implements six different I/O assemblies, as shown in [Table 9](#). You can select the active input and out assemblies, or PPOs (Parameter Process data Objects) by using parameter 879 (Profibus PPO) in the drive. The default is PPO1.

The six PPOs provide varying combinations of three basic data types:

- Parameter data (orange)
- Control, Status, Reference, and Output (blue)
- Custom configurable drive parameters (green)

The first two data types are a basic implementation of the Profidrive profile. The third data type is custom, vendor-specific I/O which allows the user to read and write any five drive parameters.

In addition, you can select "Echo" in parameter 879. This mode provides four bytes of input data that simply "echo" the four bytes of output data from the master. This mode is only useful for debugging purposes, and is not included in [Table 9](#). Note that parameter 879 is only included in X5_V0042 and later software.

I/O Assemblies

Table 9: Module Status LED

Output Input	ID	Ind	Value	CW	REF	FBW1	FBW2	FBW3	FBW4	FBW5
				SW	ACT	FBR1	FBR2	FBR3	FBR4	FBR5
	(Orange)			(Blue)			(Green)			
PP01										
PP02										
PP03										
PP04										
PP05										
PP06										

In this table, each blue-shaded block represents one byte of data. The abbreviations have the following meanings:

ID	Parameter type and number
IND	Parameter subindex
Value	Parameter value
CW	Control word
SW	Status word
REF	Frequency reference (in percent)
ACT	Actual output frequency (in percent)

Parameter Data: ID

ID	Ind	Value	CW	REF	FBW1	FBW2	FBW3	FBW4	FBW5
			SW	ACT	FBR1	FBR2	FBR3	FBR4	FBR5

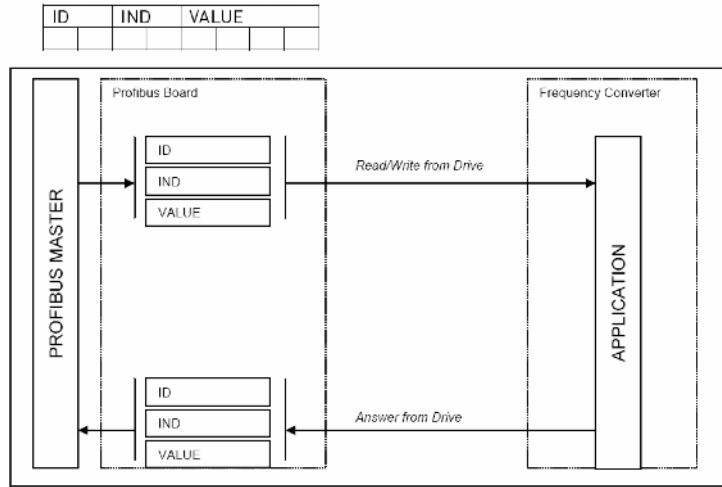

ID	Ind	Value

ID byte 1							ID byte 2								
15	14	13	12	11	10	9	8	7	6	5	4	3	2	1	0
Request / Response type				SM	Parameter Number (= Vacon ID number)										

SM: Spontaneous bit (not used)

Request / Response types

Request	Function
0	No request
1	Read parameter value (word)
2	Write parameter value (word)

Response	Function
0	No response
1	Parameter value ready (word)
7	Request rejected (+ fault code)

Fault numbers if response = 7:

Fault Number	Description
0	Illegal parameter
1	Parameter is read-only (actual values)
2	Parameter value is out of limits
17	Request temporarily rejected (ex: can be changed only for STOP state)
18	Other fault
101	Unknown request type

Parameter Data: Index

ID	Ind	Value

Not in use

Parameter Data: Data Value

ID	Ind	Value

Data word 1 (HIGH)		Data word 2 (LOW)	
byte 0	byte 1	byte 2	byte 3

In writing mode, the data to be written is placed in the field, "Data word 2."

In reading mode, the answer is in the field, "Data word 2."

"Data word 1" is normally zero.

Control and Reference: Control Word (CW)

ID	Ind	Value	CW	REF	FBW1	FBW2	FBW3	FBW4	FBW5
			SW	ACT	FBR1	FBR2	FBR3	FBR4	FBR5

Bit Description		
Bit No.	Value = 0	Value = 1
0	STOP 1 (by ramp)	ON 1
1	STOP 2 (by coast)	ON 2
2	STOP 3 (by ramp)	ON 3
3	RUN DISABLE	ENABLE
4	No action	START
5	No action	START
6	No action	START
7	No action	FAULT RESET (0 >/- 1)
8	No action	No action
9	No action	No action
10	Disable Profibus control	Enable Profibus control
11	No action	No action
12	No action	No action
13	No action	No action
14	No action	No action
15	No action	No action

Control and Reference: Status Word (SW)

ID	Ind	Value	CW	REF	FBW1	FBW2	FBW3	FBW4	FBW5
			SW	ACT	FBR1	FBR2	FBR3	FBR4	FBR5

Bit Description		
Bit No.	Value = 0	Value = 1
0	Not Ready (initial)	READY 1
1	Not Ready	READY 2
2	DISABLE	ENABLE
3	NO FAULT	FAULT ACTIVE
4	STOP 2	NO STOP 2
5	STOP 3	NO STOP 3
6	START ENABLE	START DISABLE
7	No warning	Warning
8	Reference not equal to actual value	Reference equals actual value
9	Fieldbus control OFF	Fieldbus control ON
10	Not used	Not used
11	Not used	Not used
12	FC stopped	Running
13	FC not ready	FC Ready
14	Not used	Not used
15	Not used	Not used

Profidrive State Machine:

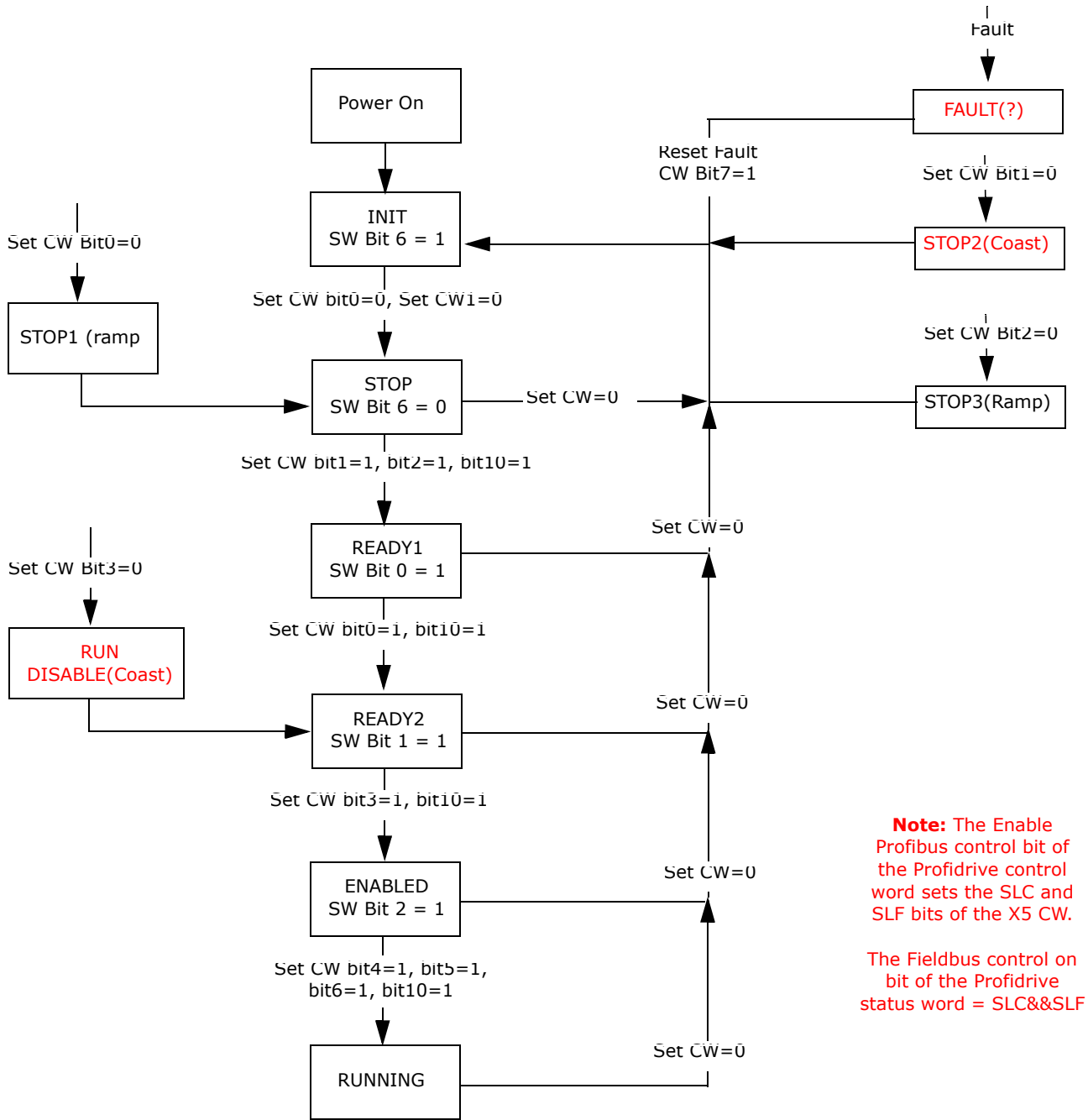

Note: The Enable Profibus control bit of the Profidrive control word sets the SLC and SLF bits of the X5 CW.
The Fieldbus control on bit of the Profidrive status word = SLC&&SLF

Reference and Actual Frequency:

ID	Ind	Value	CW	REF	FBW1	FBW2	FBW3	FBW4	FBW5
			SW	ACT	FBR1	FBR2	FBR3	FBR4	FBR5

This is the reference 1 to the frequency converter. Used normally as speed reference, the allowed scaling is -10,000 to 10,000. In the application, the value is scaled in percentage of the frequency area between set minimum and maximum frequency.

-10000	=	100.00%	(Direction reverse)
0	=	0.00%	(Direction forward)
10000	=	100.00%	(Direction forward)

Configurable FBus Parameters:

ID	Ind	Value	CW	REF	FBW1	FBW2	FBW3	FBW4	FBW5
			SW	ACT	FBR1	FBR2	FBR3	FBR4	FBR5

The Fieldbus read and write parameters allow you to set up custom I/O using any drive parameters. The output assembly permits you to write to any five parameters, and the input assembly permits you to read any five parameters. The FBus Write parameters are set up using parameters 890-894, and the FBus Read parameters are set up using parameters 880-884.

For example, if PPO2 was selected, and you wanted to write to the drive parameter Accel Time 1 (drive parameter 402) using field "FBW1" of the output assembly, you would set drive parameter 890 to a value of 402. Likewise, if you wanted to read parameter "Output Current" (drive parameter 104) using field "FBR1" of the input assembly, you would set drive parameter 880 to a value of 104.

Examples of Profibus requests

Example 1: Read drive parameter 302 (Maximum Frequency)

Command Master-Slave:

ID	112E hex	1 - Read parameter value 12E hex = Parameter 302 dec (e.g. maximum frequency)
IND	0000 hex	0000 - no meaning
VALUE	0000 0000 hex	0000 0000 - no meaning

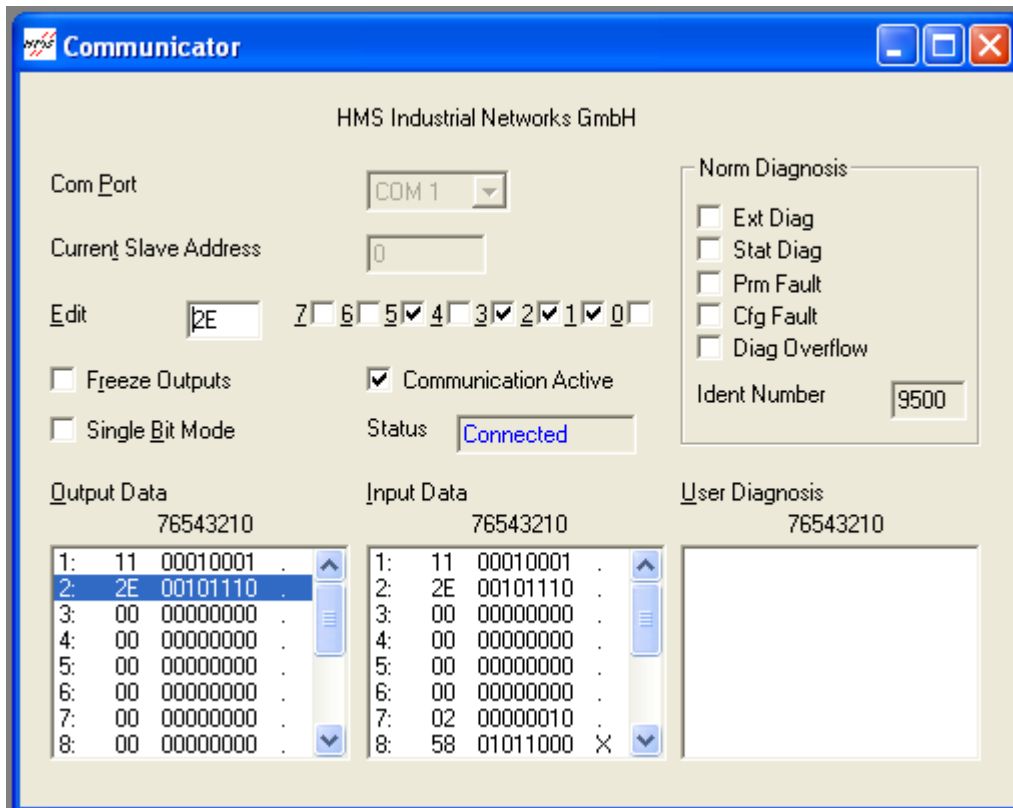

Answer Slave-Master:

ID	112E hex	1 - Parameter value ready 12E hex = Parameter 302 (= maximum frequency)
IND	0000 hex	0000 - no meaning
VALUE	0000 258 hex	0000 - high word (no meaning) 258 = 600 dec (60.0 Hz)

Example 2: Send run command to drive, and provide a reference of 50.00%

Command Master-Slave:

ID	0000 hex	No parameter request
IND	0000 hex	0000 - no meaning
VALUE	0000 0000 hex	0000 0000 - no meaning
CW	047F hex	04 7F - start command (see control word and state machine definitions)
REF	1388 hex	5000 dec - speed ref 50.00% (= 30.0 Hz if the parameter minimum frequency is 0 Hz and maximum frequency is 60 Hz)

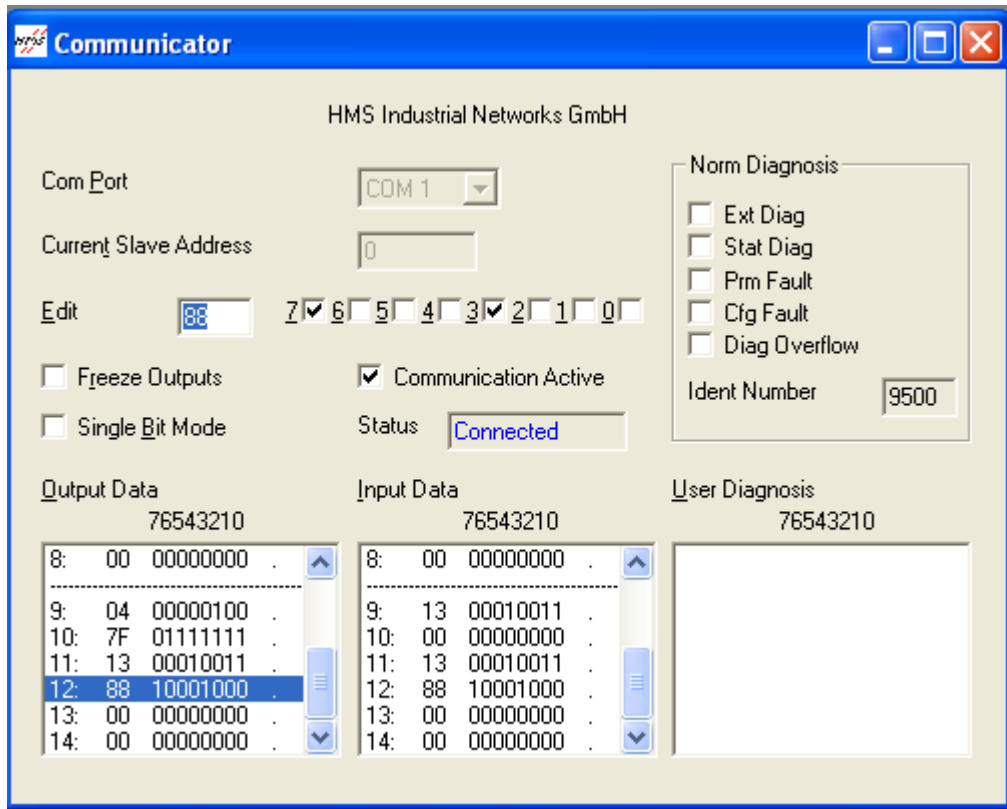

Answer Slave-Master:

ID	0000 hex	0000 - no meaning
IND	0000 hex	0000 - no meaning
VALUE	0000 0000	0000 0000 (no meaning)
SW	0013 hex	0013 - frequency converter status (see status word and state machine definitions)
ACT	1388 hex	Current speed 50.00% (= 30.00 Hz if the parameter minimum frequency is 0 Hz and the maximum frequency is 60 Hz)

HEAD OFFICE AND PRODUCTION:**Vaasa**

Vacon Plc
Runsorintie 7
65380 Vaasa
firstname.lastname@vacon.com
telephone: +358 (0)201 2121
fax: +358 (0)201 212 205

PRODUCTION:**Suzhou, China**

Vacon Suzhou Drives Co. Ltd.
Building 11A
428# Xinglong Street, SIP
Suchun Industrial Square
Suzhou 215126
telephone: + 86 512 62836630
fax: + 86 512 62836618

Naturno, Italy

Vacon S.R.I
Via Zone Industriale, 11
39025 Naturno

PRODUCTION:**Chambersburg, USA**

3181 Black Gap Road
Chambersburg, PA 17202

TB Wood's (India) Pvt. Ltd.

#27, 'E' Electronics City
Hosur Road
Bangalore - 560 100
India
Tel. +91-80-30280123
Fax. +91-80-30280124

SALES COMPANIES AND REPRESENTATIVE OFFICES:**FINLAND****Helsinki**

Vacon Plc
Äyritie 8
01510 Vantaa
telephone: +358 (0)201 212 600
fax: +358 (0)201 212 699

Tampere

Vacon Plc
Vehnämyllynkatu 18
33580 Tampere
telephone: +358 (0)201 2121
fax: +358 (0)201 212 750

AUSTRALIA

Vacon Pacific Pty Ltd
5/66-74, Micro Circuit
Dandenong South, VIC 3175
telephone: +61 (0)3 9238 9300
fax: +61 (0)3 92389310

AUSTRIA

Vacon AT Antriebssysteme GmbH
Aumühlweg 21
2544 Leobersdorf
telephone: +43 2256 651 66
fax: +43 2256 651 66 66

BELGIUM

Vacon Benelux NV/SA
Interleuvenlaan 62
3001 Heverlee (Leuven)
telephone: +32 (0)16 394 825
fax: +32 (0)16 394 827

BRAZIL

Vacon Brazil
Alameda Mamoré, 535
Alphaville - Barueri - SP
Tel. +55 11 4166-5707
Fax. +55 11 4166-5567

CANADA

Vacon Canada
221 Griffith Road
Stratford, Ontario N5A 6T3
telephone: +1 (519) 508-2323
fax: +1 (519) 508-2324

CHINA

Vacon Suzhou Drives Co. Ltd.
Beijing Branch
A528, Grand Pacific Garden Mansion
8A Guanghua Road
Beijing 100026
telephone: + 86 10 51280006
fax: +86 10 65813733

CZECH REPUBLIC

Vacon s.r.o.
Kodanska 1441/46
110 00 Prague 10
telephone: +420 234 063 250
fax: +420 234 063 251

FRANCE

Vacon France
ZAC du Fresne
1 Rue Jacquard - BP72
91280 Saint Pierre du Perray CDIS
telephone: +33 (0)1 69 89 60 30
fax: +33 (0)1 69 89 60 40

GERMANY

Vacon GmbH
Gladbecker Strasse 425
45329 Essen
telephone: +49 (0)201 806 700
fax: +49 (0)201 806 7099

Vacon OEM Business Center GmbH

Industriestr. 13
51709 - Marienheide
Germany
Tel. +49 02264 17-17
Fax. +49 02264 17-126

INDIA

Vacon Drives & Control Plc
Plot No 352
Kapaleeshwar Nagar
East Coast Road
Neelangarai
Chennai-600041
Tel. +91 44 244 900 24/25

ITALY

Vacon S.p.A.
Via F.lli Guerra, 35
42100 Reggio Emilia
telephone: +39 0522 276811
fax: +39 0522 276890

THE NETHERLANDS

Vacon Benelux BV
Weide 40
4206 CJ Gorinchem
telephone: +31 (0)183 642 970
fax: +31 (0)183 642 971

NORWAY

Vacon AS
Bentsrudveien 17
3080 Holmestrand
telephone: +47 330 96120
fax: +47 330 96130

ROMANIA

Vacon Romania - Reprezentanta
Cuza Voda 1
400107 Cluj Napoca
Tel. +40 364 118 981
Fax. +40 364 118 981

RUSSIA

ZAO Vacon Drives
UL. Letchika Babushkina 1,
Stroenie 3
129344 Moscow
telephone: +7 (495) 363 19 85
fax: +7 (495) 363 19 86

ZAO Vacon Drives
2ya Sovetskaya 7, office 210A
191036 St. Petersburg
telephone: +7 (812) 332 1114
fax: +7 (812) 279 9053

SLOVAKIA

Vacon s.r.o. (Branch)
Seberiniho 1
821 03 Bratislava
Tel. +421 243 330 202
Fax. +421 243 634 389

SPAIN

Vacon Drives Ibérica S.A.
Miquel Servet, 2. P.I. Bufalvent
08243 Manresa
telephone: +34 93 877 45 06
fax: +34 93 877 00 09

SWEDEN

Vacon AB
Anderstorsvägen 16
171 54 Solna
telephone: +46 (0)8 293 055
fax: +46 (0)8 290 755

THAILAND

Vacon South East Asia
335/32 5th-6th floor
Srinakarin Road, Prawet
Bangkok 10250
Tel. +66 (0)2366 0768

UKRAINE

Vacon Drives Ukraine (Branch)
42-44 Shovkovychna Str.
Regus City Horizon Tower
Kiev 01601, Ukraine
Tel. +380 44 459 0579
Fax +380 44 490 1200

UNITED ARAB EMIRATES

Vacon Middle East and Africa
Block A, Office 4A 226
P.O.Box 54763
Dubai Airport Free Zone
Dubai
Tel. +971 (0)4 204 5200
Fax: +971 (0)4 204 5203

UNITED KINGDOM

Vacon Drives (UK) Ltd.
18, Maizefield
Hinckley Fields Industrial Estate
Hinckley
LE10 1YF Leicestershire
telephone: +44 (0)1455 611 515
fax: +44 (0)1455 611 517

UNITED STATES

Vacon, Inc.
3181, Black Gap Road
Chambersburg, PA 17202
telephone: +1 (877) 822-6606
fax: +1 (717) 267-0140

